

Note: All dimensions are in millimeter

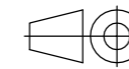

REV.	DESCRIPTIONS	DATE	APPROVED

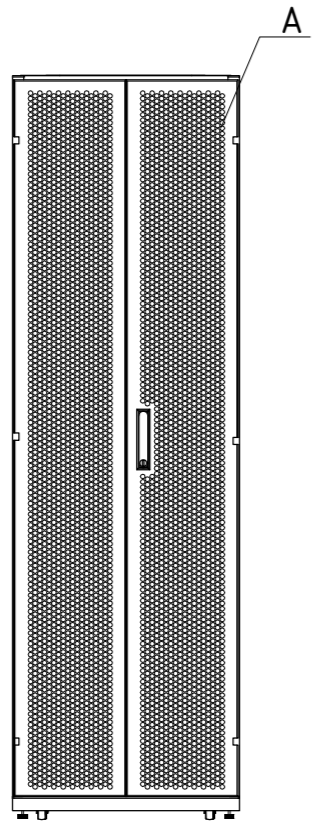

REAR VIEW

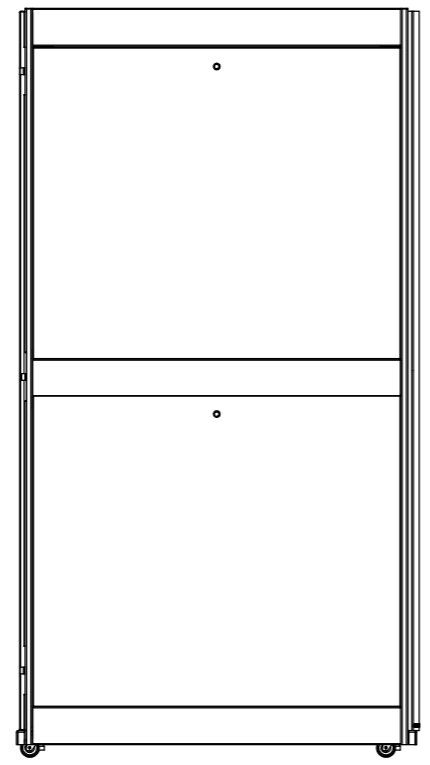

SIDE VIEW

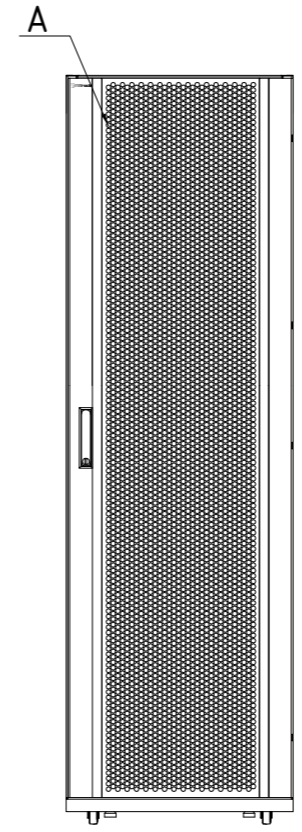

FRONT VIEW

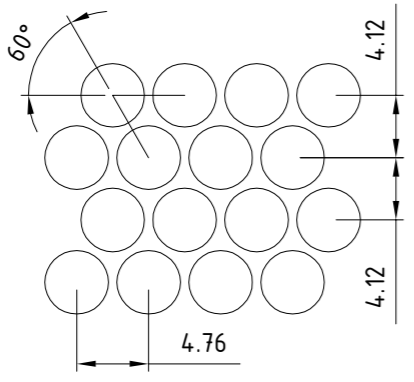
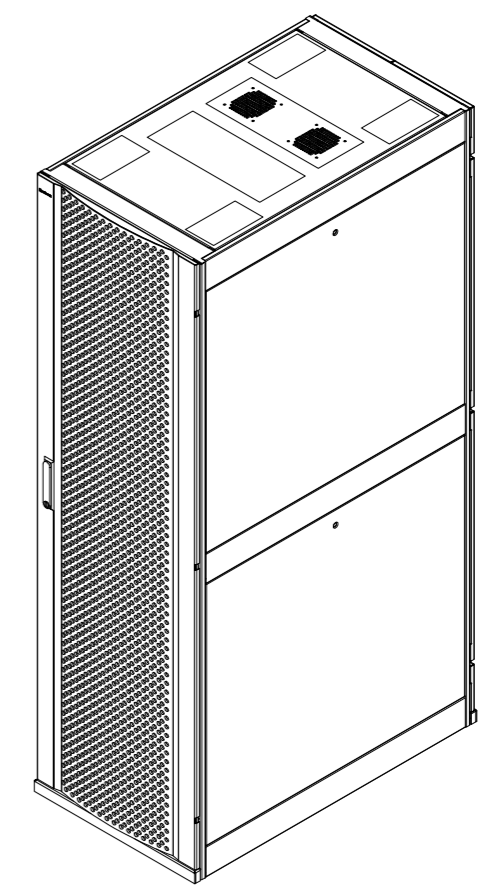

Detail A  
Scale 2:1

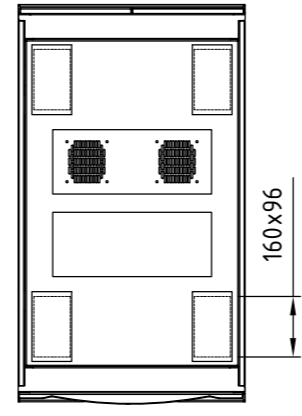

TOP VIEW

Lot EB6, Hiep Phuoc Industrial Park, Nha Be District, HCMC, Vietnam. <small>THIS DRAWING AND THE INFORMATION IT CONTAINS ARE THE SOLE PROPERTY OF NSP CO.,LTD. ANY REPRODUCTION IN PART OR AS A WHOLE WITHOUT THE WRITTEN PERMISSION IS PROHIBITED.</small>	S-SERIES CABINET	Scale 1:20	VRS		
		Size A3	Rev. 00	Date of issue 10/03/2018	Sheet 1/6
Created by	Checked by	Approved by	CUSTOMER DRAWING		PICTORIAL DRAWING

Note: All dimensions are in millimeter

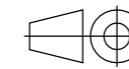

REV.	DESCRIPTIONS	DATE	APPROVED

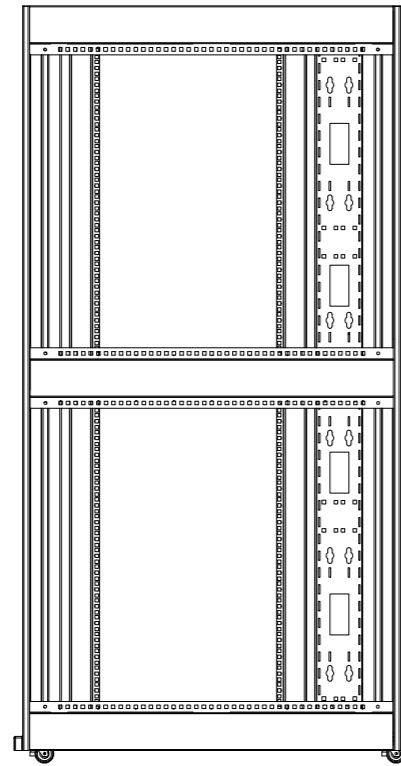

SIDE VIEW  
(REMOVE DOOR)

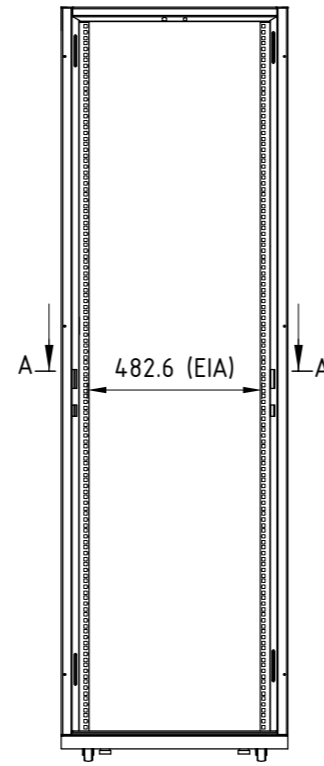

FRONT VIEW  
(REMOVE DOOR)

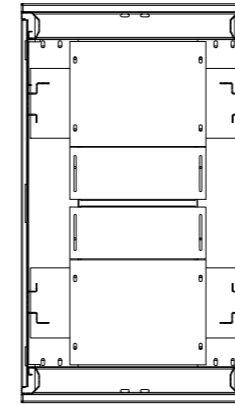

A-A



Detail D

Detail B

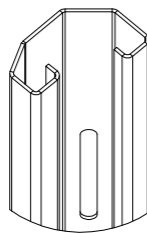

Detail C

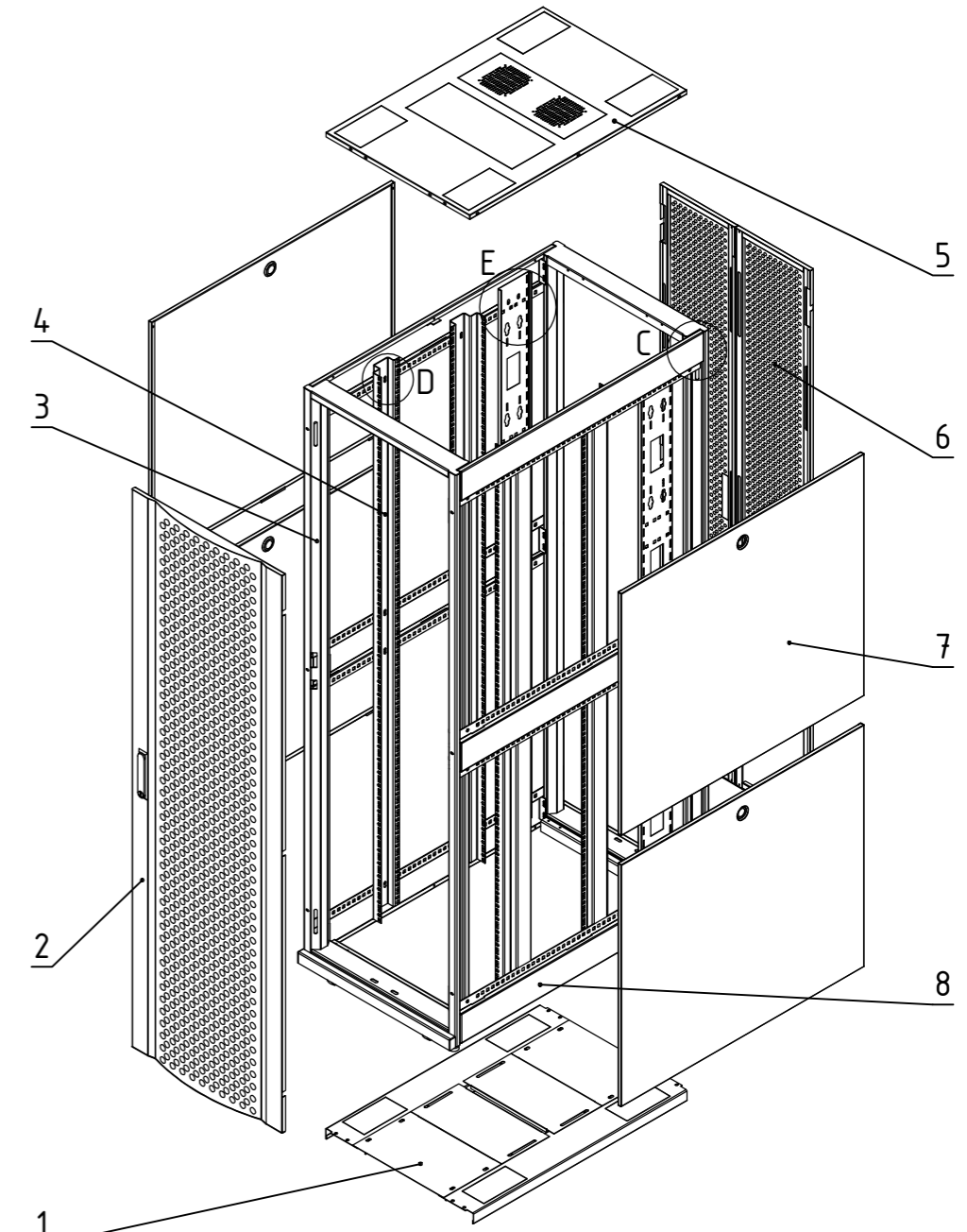
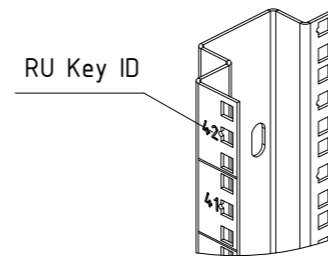

EXPLODED VIEW

8	VRS.XX0.02.000	MOUNTING ANGLE	04/06	SPCC 2.0	-
7	VRS.XX0.05.000	SIDE PANEL	02/04	SPCC 1.0	-
6	VRS.XX0.04.000	DOUBLE OPEN REAR DOOR	02	SPCC 1.2	-
5	VRS.XX0.06.000	TOP COVER	01	SPCC 1.2	-
4	VRS.XX0.08.000	MOUNTING PROFILE	04/06	SPCC 2.0	-
3	VRS.XX0.08.000	MAIN FRAME	02	SPCC 2.0	-
2	VRS.XX0.03.000	SINGLE OPEN FRONT DOOR	01	SPCC 1.2	-
1	VRS.XX0.06.000	BOTTOM PANEL	01	SPCC 1.2	-
ITEM	PART NO.	DESCRIPTIONS	Q'TY	MATERIAL	DRAWING NO.

Lot EB6, Hiep Phuoc Industrial Park, Nha Be District, HCMC, Vietnam. <small>THIS DRAWING AND THE INFORMATION IT CONTAINS ARE THE SOLE PROPERTY OF NSP CO.,LTD. ANY REPRODUCTION IN PART OR AS A WHOLE WITHOUT THE WRITTEN PERMISSION IS PROHIBITED.</small>	S-SERIES CABINET		Scale	VRS		
			1:20	Rev.	Date of issue	Sheet
Created by	Checked by	Approved by	A3	00	10/03/2018	2/6
CUSTOMER DRAWING			PICTORIAL DRAWING			

Note: All dimensions are in millimeter

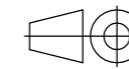

REV.	DESCRIPTIONS	DATE	APPROVED

BOTTOM  
PANEL

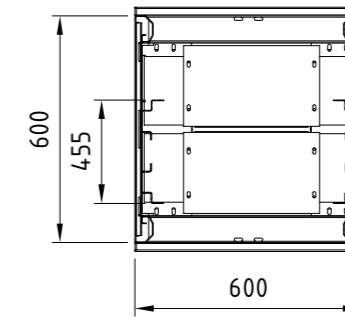
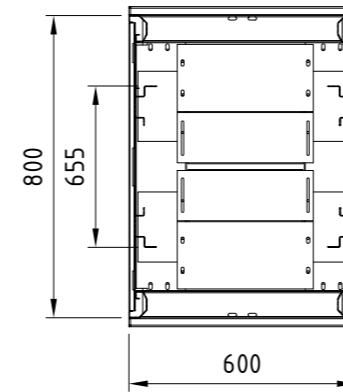
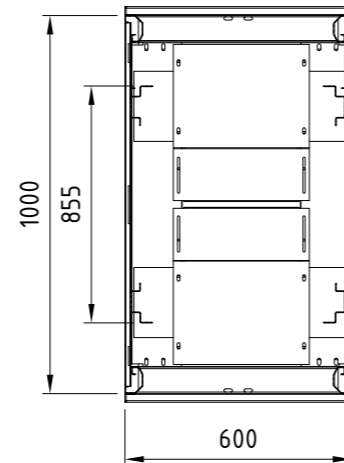
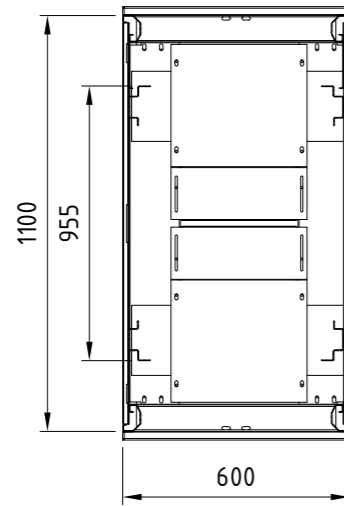

TOP  
PANEL

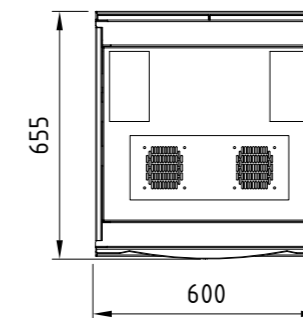
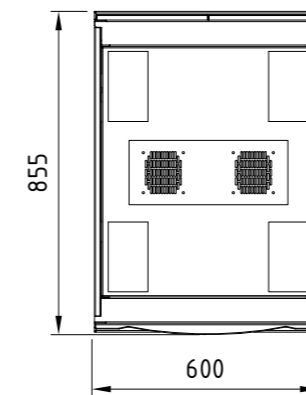
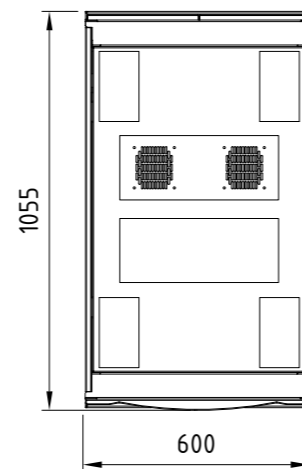
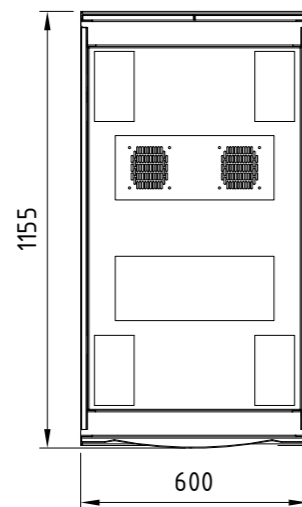

Lot EB6, Hiep Phuoc Industrial Park, Nha Be District, HCMC, Vietnam. <small>THIS DRAWING AND THE INFORMATION IT CONTAINS ARE THE SOLE PROPERTY OF NSP CO.,LTD. ANY REPRODUCTION IN PART OR AS A WHOLE WITHOUT THE WRITTEN PERMISSION IS PROHIBITED.</small>	S-SERIES CABINET TOP BOTTOM PANEL W600		Scale 1:20	VRS		
	Created by	Checked by	Approved by	Size A3	Rev. 00	Date of issue 10/03/2018
CUSTOMER DRAWING				PICTORIAL DRAWING		

Note: All dimensions are in millimeter

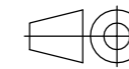

REV.	DESCRIPTIONS	DATE	APPROVED

BOTTOM  
PANEL

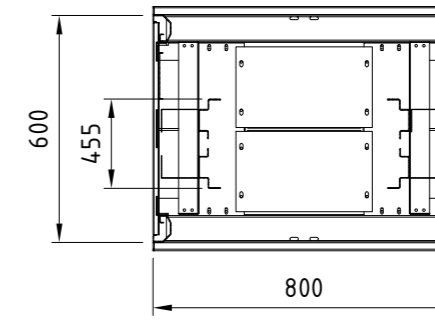
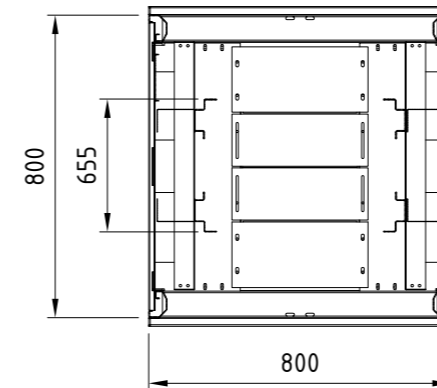
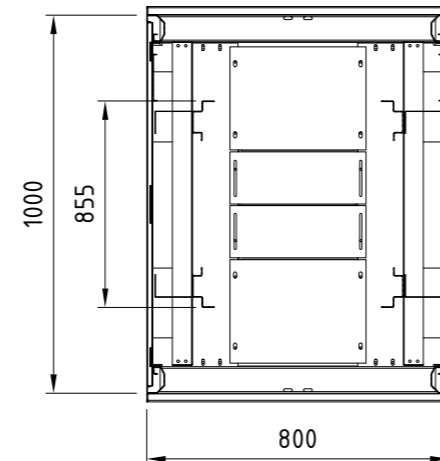
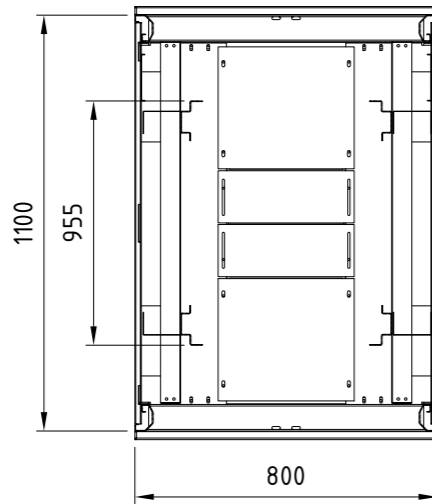

TOP  
PANEL

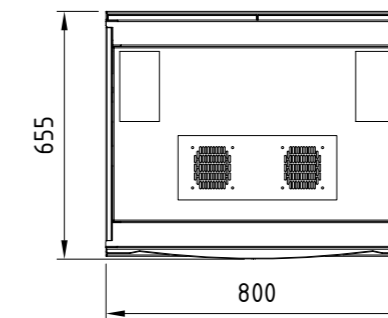
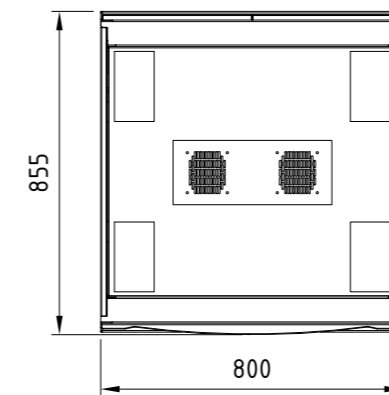
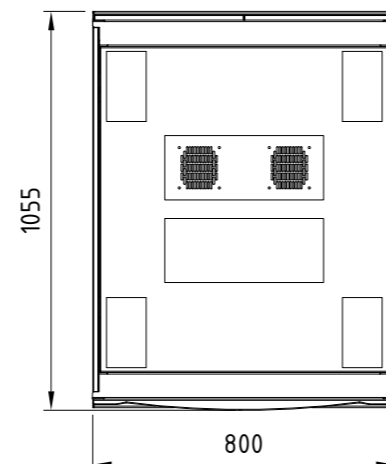
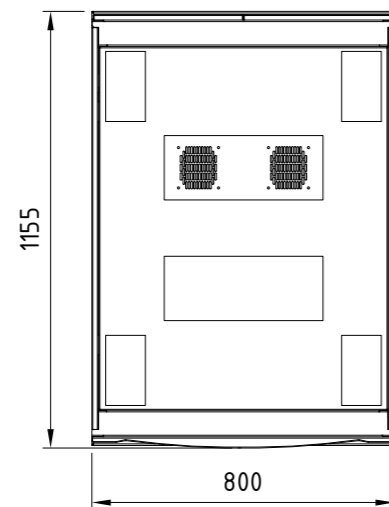

Lot EB6, Hiep Phuoc Industrial Park, Nha Be District, HCMC, Vietnam. <small>THIS DRAWING AND THE INFORMATION IT CONTAINS ARE THE SOLE PROPERTY OF NSP CO.,LTD. ANY REPRODUCTION IN PART OR AS A WHOLE WITHOUT THE WRITTEN PERMISSION IS PROHIBITED.</small>	S-SERIES CABINET TOP BOTTOM PANEL W800		Scale 1:20	VRS		
	Created by	Checked by	Approved by	Size A3	Rev. 00	Date of issue 10/03/2018
CUSTOMER DRAWING				PICTORIAL DRAWING		

Note: All dimensions are in millimeter

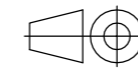

REV.	DESCRIPTIONS	DATE	APPROVED

SIDE VIEW

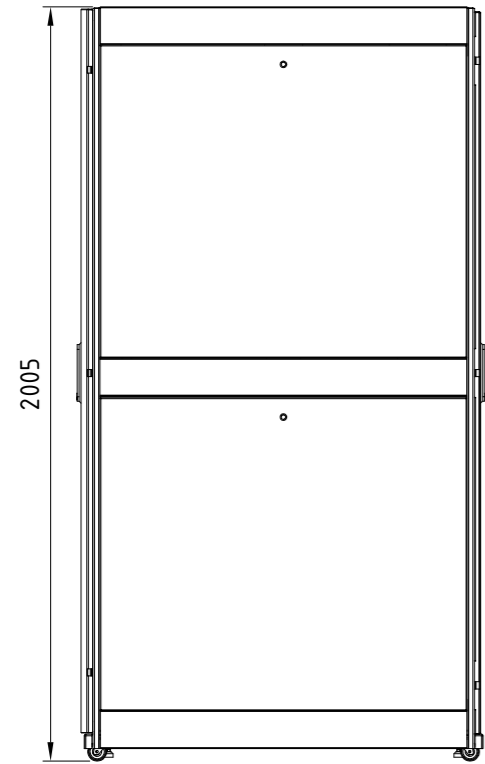

42U CABINET

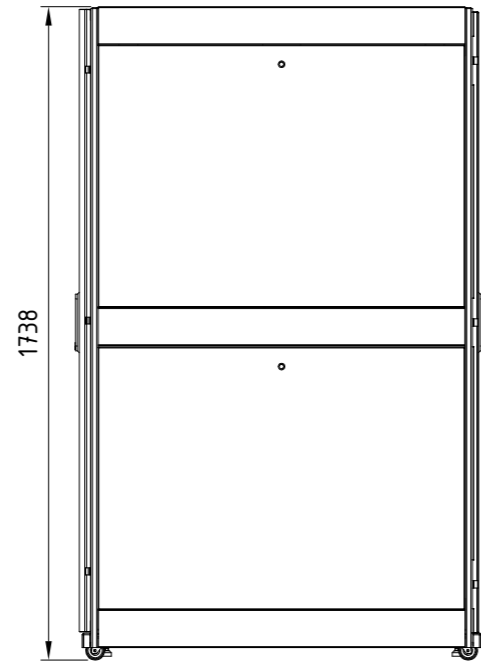

36U CABINET

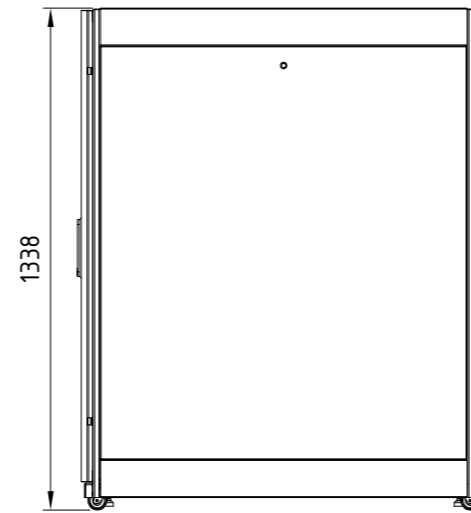

27U CABINET

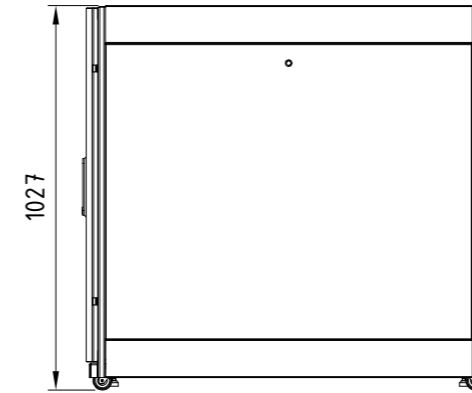

20U CABINET

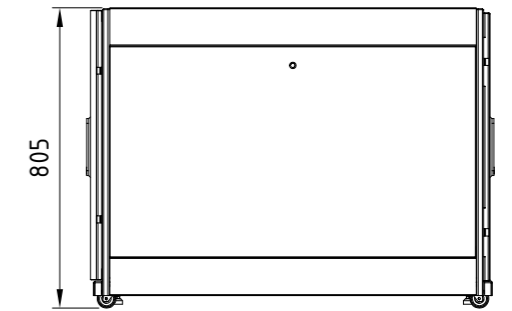

15U CABINET

Lot EB6, Hiep Phuoc Industrial Park, Nha Be District, HCMC, Vietnam. <small>THIS DRAWING AND THE INFORMATION IT CONTAINS ARE THE SOLE PROPERTY OF NSP CO.,LTD. ANY REPRODUCTION IN PART OR AS A WHOLE WITHOUT THE WRITTEN PERMISSION IS PROHIBITED.</small>	S-SERIES CABINET UNITS		Scale 1:20	VRS		
			Size A3	Rev. 00	Date of issue 10/03/2018	Sheet 5/6
Created by	Checked by	Approved by	CUSTOMER DRAWING		PICTORIAL DRAWING	

Note: All dimensions are in millimeter

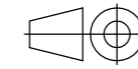

REV.	DESCRIPTIONS	DATE	APPROVED

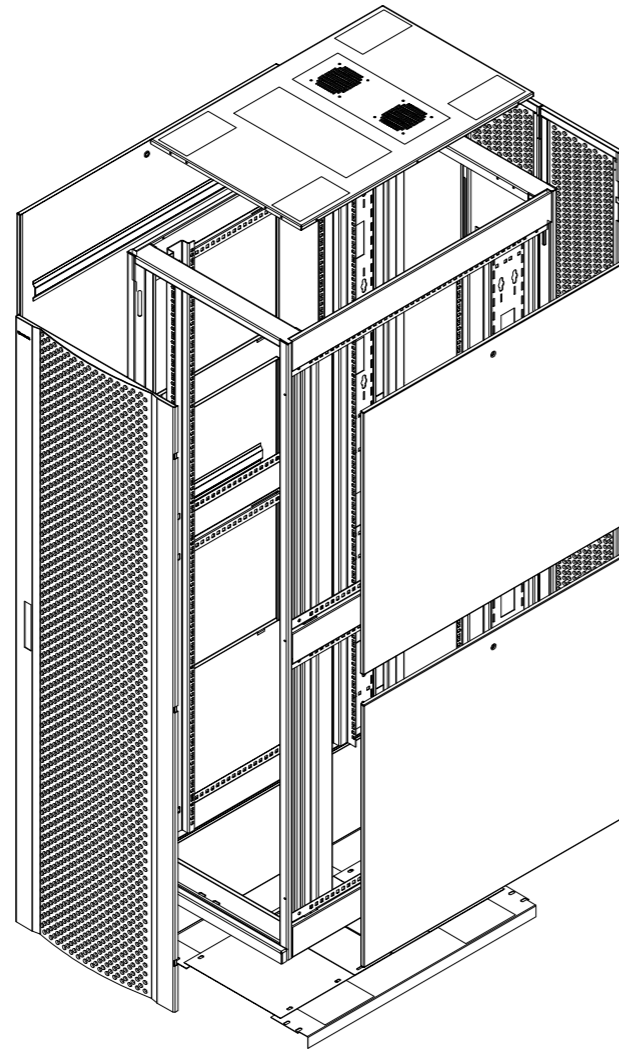

W600 CABINET

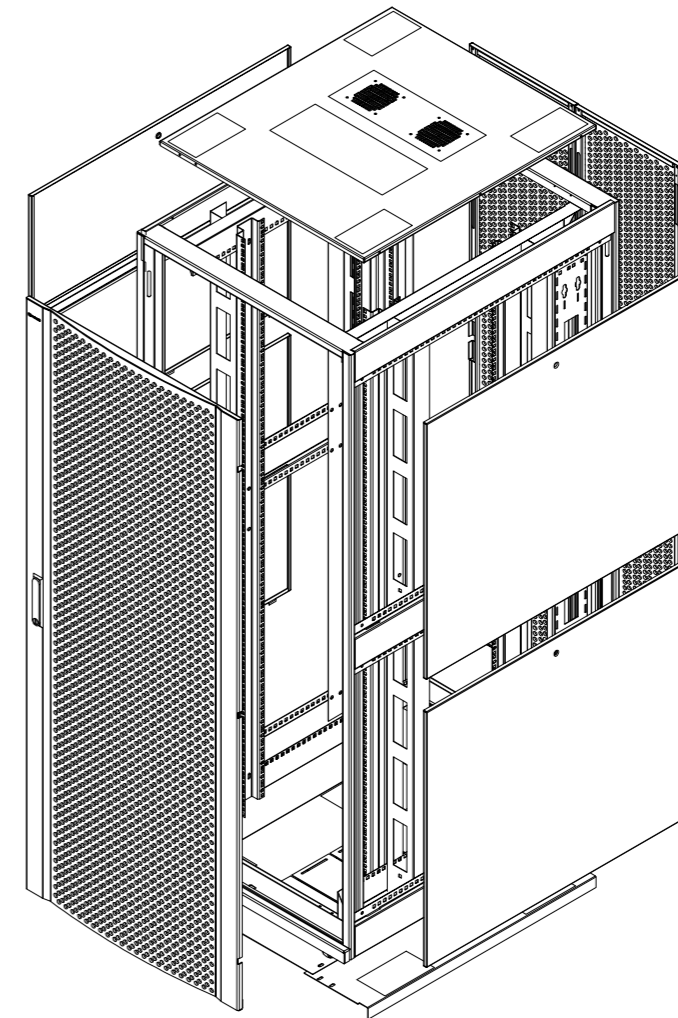

W800 CABINET

Lot EB6, Hiep Phuoc Industrial Park, Nha Be District, HCMC, Vietnam. <small>THIS DRAWING AND THE INFORMATION IT CONTAINS ARE THE SOLE PROPERTY OF NSP CO.,LTD. ANY REPRODUCTION IN PART OR AS A WHOLE WITHOUT THE WRITTEN PERMISSION IS PROHIBITED.</small>	S-SERIES CABINET		Scale 1:20	VRS			
	Created by	Checked by	Approved by	Size A3	Rev. 00	Date of issue 10/03/2018	Sheet 6/6
CUSTOMER DRAWING				PICTORIAL DRAWING			